

# Řetězová kola

## BS Řetězová kola – s nábojem

**04B 6 x 2.8 mm**

ŘETĚZOVÉ KOLO	mm	ŘETĚZ	mm
Poloměr zuby $r_3$	6.0	Rozteč	6.000
Poloměr c	0.7	Šířka mezi vnitřními destičkami	2.800
Šířka zuby B1	2.6	Průměr válečku	4.000

Typ 1 (C45)

Zuby	Vnější prům. $d_e$	Průměr rozteče $d_p$	Průměr náboje $d_m$	Simplex Délka přes vývrt A	Vývrt D1	Typ
8	18.0	15.67	9.8	10	5	1
9	19.9	17.54	11.5	10	5	1
10	21.7	19.42	13.0	10	6	1
11	23.6	21.30	14.0	10	6	1
12	25.4	23.18	16.0	10	6	1
13	27.3	25.05	18.0	10	6	1
14	29.2	26.96	20.0	10	6	1
15	31.1	28.86	20.0	10	6	1
16	33.0	30.76	20.0	13	8	1
17	35.0	32.65	20.0	13	8	1
18	36.9	34.55	20.0	13	8	1
19	38.8	36.44	20.0	13	8	1
20	40.7	38.34	20.0	13	8	1
21	42.6	40.25	25.0	13	8	1
22	44.5	42.16	25.0	13	8	1
23	46.4	44.06	25.0	13	8	1
24	48.3	45.96	25.0	13	8	1
25	50.2	47.87	25.0	13	8	1
26	52.1	49.77	30.0	15	8	1
27	54.0	51.67	30.0	15	8	1
28	55.9	53.58	30.0	15	8	1
29	57.8	55.50	30.0	15	8	1
30	59.8	57.42	30.0	15	8	1
31	61.7	59.31	30.0	15	10	1
32	63.6	61.21	30.0	15	10	1
33	65.5	63.11	30.0	15	10	1
34	67.4	65.02	30.0	15	10	1
35	69.3	66.93	30.0	15	10	1
36	71.2	68.84	30.0	15	10	1
37	73.1	70.75	30.0	15	10	1
38	75.0	72.66	30.0	15	10	1
39	76.9	74.56	30.0	15	10	1
40	78.9	76.47	30.0	15	10	1
45	88.5	86.01	40.0	18	12	1
50	98.0	95.55	50.0	20	12	1
57	111.4	108.93	50.0	20	12	1

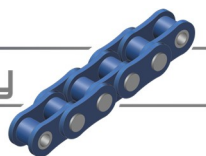

# Řetězová kola

## BS Řetězová kola – s nábojem

**05B 8 x 3 mm**

ŘETĚZOVÉ KOLO	mm	ŘETĚZ	mm
Poloměr zubu $r_3$	8.0	Rozeč	8.000
Poloměr c	1.0	Šířka mezi vnitřními destičkami	3.000
Šířka zubu $b_1$	2.7	Průměr válečku	5.000
Šířka zubu $B_1$	2.8		
Šířka zubu $B_2$	8.3		

Zuby	Vnější prům. $d_e$	Průměr rozeče $d_p$	Simplex			Duplex			Typ
			Průměr náboje $d_m$	Délka přes vývrt A	Vývrt $D_1$	Průměr náboje $d_m$	Délka přes vývrt A	Vývrt $D_1$	
8	24.0	20.90	13	12	6	12	18	6	1
9	26.6	23.39	15	12	6	15	18	6	1
10	29.2	25.89	17	12	6	17	18	8	1
11	31.7	28.39	18	13	7	19	18	8	1
12	34.2	30.91	20	13	7	21	18	8	1
13	36.7	33.42	23	13	7	24	18	8	1
14	39.2	35.95	25	13	7	26	18	8	1
15	41.7	38.48	28	13	7	29	18	8	1
16	44.3	41.01	30	14	8	32	20	10	1
17	46.8	43.53	30	14	8	34	20	10	1
18	49.3	46.07	30	14	8	37	20	10	1
19	51.9	48.61	30	14	8	39	20	10	1
20	54.4	51.14	30	14	8	40	20	10	1
21	57.0	53.67	35	14	8	40	20	10	1
22	59.5	56.21	35	14	8	40	20	10	1
23	62.0	58.75	35	14	8	40	20	10	1
24	64.6	61.29	35	14	8	40	20	10	1
25	67.5	63.83	35	14	8	40	20	10	1
26	69.5	66.37	40	16	10	50	22	12	1
27	72.2	68.91	40	16	10	50	22	12	1
28	74.8	71.45	40	16	10	50	22	12	1
29	77.3	73.99	40	16	10	50	22	12	1
30	79.8	76.53	40	16	10	50	22	12	1
31	82.4	79.08	40	16	12	60	22	12	1
32	84.9	81.61	40	16	12	60	22	12	1
33	87.5	84.16	40	16	12	60	22	12	1
34	90.0	86.70	40	16	12	60	22	12	1
35	92.5	89.24	40	16	12	60	22	12	1
36	95.0	91.79	40	16	12	60	22	12	1
37	97.6	94.33	40	16	12	60	22	12	1
38	100.2	96.88	40	16	12	60	22	12	1
39	102.7	99.42	40	16	12	60	22	12	1
40	105.2	101.97	40	16	12	60	22	12	1
45	118.0	114.69	60	20	12	-	-	-	1
50	130.7	127.41	60	20	12	-	-	-	1
57	148.6	145.22	80	20	14	-	-	-	1
76	197.9	193.59	78	34.4	-	-	-	-	1

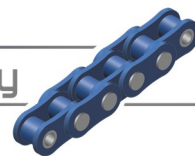

## BS Řetězová kola – s nábojem

**06B 3/8" x 7/32"**

<p>ŘETĚZOVÉ KOLO mm</p> <p>Poloměr zubu <math>r_3</math> 10.0</p> <p>Poloměr c 1.0</p> <p>Šířka zubu <math>b_1</math> 5.2</p> <p>Šířka zubu <math>B_1</math> 5.3</p> <p>Šířka zubu <math>B_2</math> 15.4</p> <p>Šířka zubu <math>B_3</math> 25.6</p>	<p>ŘETĚZ mm</p> <p>Rozteč 9.525</p> <p>Šířka mezi vnitřními destičkami 5.720</p> <p>Průměr válečku 6.350</p>	
--	--	--

<p>Typ 1 (C45)</p>	<p>Typ 2 (GG22)</p>	<p>Typ 1 (C45)</p>	<p>Typ 2 (GG22)</p>	<p>Typ 1 (C45)</p>	<p>Typ 2 (GG22)</p>
--------------------	---------------------	--------------------	---------------------	--------------------	---------------------

Zuby	Vnější prům. $d_e$	Průměr rozteče $d_p$	Průměr náboje $d_m$	Simplex		Duplex			Triplex			Typ
				Průměr náboje $d_m$	Délka přes vývrt A	Vývrt D1	Průměr náboje $d_m$	Délka přes vývrt A	Vývrt D1	Průměr náboje $d_m$	Délka přes vývrt A	
8	28.0	24.89	15	22	8	15	22	8	15	32	8	1
9	31.0	27.85	18	22	8	18	22	8	18	32	8	1
10	34.0	30.82	20	22	8	20	22	8	20	32	10	1
11	37.0	33.80	22	25	8	22	25	10	22	35	12	1
12	40.0	36.80	25	25	8	25	25	10	25	35	12	1
13	43.0	39.80	28	25	10	28	25	10	28	35	12	1
14	46.3	42.80	31	25	10	31	25	10	31	35	12	1
15	49.3	45.81	34	25	10	34	25	10	34	35	12	1
16	52.3	48.82	37	28	10	37	30	12	37	35	12	1
17	55.3	51.83	40	28	10	40	30	12	40	35	12	1
18	58.3	54.85	43	28	10	43	30	12	43	35	12	1
19	61.3	57.87	45	28	10	46	30	12	46	35	12	1
20	64.3	60.89	46	28	10	49	30	12	49	35	12	1
21	68.0	63.91	48	28	12	52	30	16	52	40	16	1
22	71.0	66.93	50	28	12	55	30	16	55	40	16	1
23	73.5	69.95	52	28	12	58	30	16	58	40	16	1
24	77.0	72.97	54	28	12	61	30	16	61	40	16	1
25	80.0	76.00	57	28	12	64	30	16	64	40	16	1
26	83.0	79.02	60	28	12	67	30	16	67	40	16	1
27	86.0	82.04	60	28	12	70	30	16	70	40	16	1
28	89.0	85.07	60	28	12	73	30	16	73	40	16	1
29	92.0	88.09	60	28	12	76	30	16	76	40	16	1
30	94.7	91.12	60	28	12	79	30	16	79	40	16	1
31	98.3	94.15	65	30	14	80	30	16	80	40	16	1
32	101.3	97.17	65	30	14	80	30	16	80	40	16	1
33	104.3	100.20	65	30	14	80	30	16	80	40	16	1
34	107.3	103.23	65	30	14	80	30	16	85	40	16	1
35	110.4	106.26	65	30	14	80	30	16	85	40	16	1
36	113.4	109.29	70	30	14	90	30	16	90	40	16	1
37	116.4	112.32	70	30	14	90	30	16	90	40	16	1
38	119.5	115.34	70	30	14	90	30	16	90	40	16	1
39	122.5	118.37	70	30	14	90	30	16	90	40	16	1
40	125.5	121.40	70	30	14	90	30	16	90	40	16	1
38	119.5	115.34	70	32	20	80	40	20	90	56	24	2
45	140.7	136.54	70	32	20	80	40	20	90	56	24	2
57	176.9	172.91	70	32	20	80	40	20	90	56	24	2
76	234.9	230.49	70	32	20	80	40	20	100	56	24	2
95	292.5	288.08	80	40	20	90	45	20	100	56	24	2
114	349.6	345.68	80	40	20	95	45	20	100	56	24	2

Všechny rozměry jsou v milimetrech, pokud není uvedeno jinak.

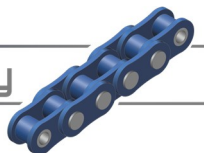

## BS Řetězová kola – s nábojem

081 1/2" x 1/8"

ŘETĚZOVÉ KOLO	mm	ŘETĚZ	mm
Poloměr zubu $r_3$	13.0	Rozteč	12.700
Poloměr c	1.0	Šířka mezi vnitřními destičkami	3.300
Šířka zubu B1	3.0	Průměr válečku	7.750

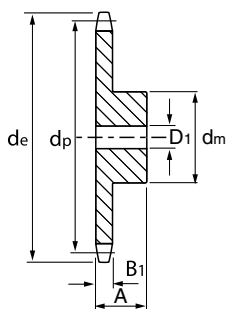

Typ 1 (C45)

Zuby	Vnější prům. $d_e$	Průměr rozteče $d_p$	Průměr náboje $d_m$	Simplex Délka přes vývrt A	Vývrt D1	Typ
8	37.2	33.18	21	14	8	1
9	41.5	37.13	25	14	8	1
10	46.2	41.10	28	14	8	1
11	49.6	45.07	31	16	8	1
12	53.9	49.07	35	16	8	1
13	58.4	53.06	39	16	8	1
14	62.8	57.07	43	16	8	1
15	66.8	61.09	47	16	8	1
16	70.9	65.10	50	18	10	1
17	74.9	69.11	50	18	10	1
18	78.9	73.14	50	18	10	1
19	82.9	77.16	50	18	10	1
20	86.9	81.19	50	18	10	1
21	91.0	85.22	60	20	12	1
22	95.0	89.24	60	20	12	1
23	99.0	93.27	60	20	12	1
24	103.0	97.29	60	20	12	1
25	107.1	101.33	60	20	12	1
26	111.2	105.36	70	20	16	1
27	115.4	109.40	70	20	16	1
28	119.4	113.42	70	20	16	1
29	123.4	117.46	70	20	16	1
30	127.5	121.50	70	20	16	1
31	131.5	125.54	70	20	16	1
32	135.5	129.56	70	20	16	1
33	139.6	133.60	70	20	16	1
34	143.6	137.64	70	20	16	1
35	147.6	141.68	70	20	16	1
36	151.7	145.72	70	25	16	1
37	155.7	149.76	70	25	16	1
38	159.8	153.80	70	25	16	1
39	163.8	157.83	70	25	16	1
40	167.8	161.87	70	25	16	1

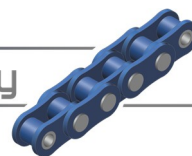

## BS Řetězová kola – s nábojem

083 / 084 1/2" x 3/16"

ŘETĚZOVÉ KOLO	mm	ŘETĚZ	mm
Poloměr zubu $r_3$	13.0	Rozteč	12.700
Poloměr c	1.3	Šířka mezi vnitřními destičkami	4.880
Šířka zubu B1	4.5	Průměr válečku	7.750

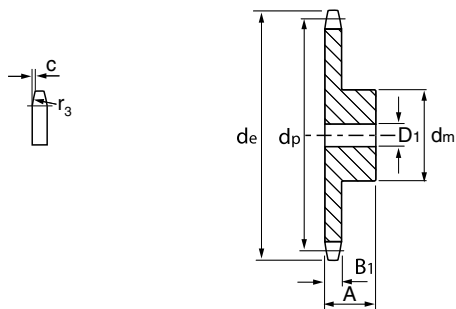

Typ 1 (C45)

Zuby	Vnější prům. $d_e$	Průměr rozteče $d_p$	Průměr náboje $d_m$	Simplex Délka přes vývrt A	Vývrt D1	Typ
8	38.5	33.18	21	14	8	1
9	41.5	37.13	25	14	8	1
10	46.2	41.10	28	14	8	1
11	49.6	45.07	31	16	8	1
12	53.9	49.07	35	16	8	1
13	58.4	53.06	39	16	8	1
14	62.8	57.07	43	16	8	1
15	66.8	61.09	47	16	8	1
16	70.9	65.10	50	18	10	1
17	74.9	69.10	50	18	10	1
18	78.9	73.14	50	18	10	1
19	82.9	77.16	50	18	10	1
20	86.9	81.19	50	18	10	1
21	91.0	85.22	60	20	12	1
22	95.0	89.24	60	20	12	1
23	99.0	93.27	60	20	12	1
24	103.0	97.29	60	20	12	1
25	107.1	101.33	60	20	12	1
26	111.2	105.36	70	20	16	1
27	115.4	109.40	70	20	16	1
28	119.4	113.42	70	20	16	1
29	123.4	117.46	70	20	16	1
30	127.5	121.50	70	20	16	1
31	131.5	125.54	70	20	16	1
32	135.5	129.56	70	20	16	1
33	139.6	133.60	70	20	16	1
34	143.6	137.64	70	20	16	1
35	147.6	141.68	70	20	16	1
36	151.7	145.72	70	25	16	1
37	155.7	149.76	70	25	16	1
38	159.8	153.80	70	25	16	1
39	163.8	157.83	70	25	16	1
40	167.8	161.87	70	25	16	1

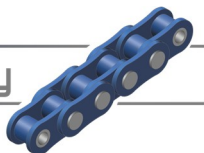

# Řetězová kola

## BS Řetězová kola – s nábojem

**085 1/2" x 1/4"**

ŘETĚZOVÉ KOLO	mm	ŘETĚZ	mm
Poloměr zubu $r_3$	13.0	Rozteč	12.700
Poloměr c	1.3	Šířka mezi vnitřními destičkami	6.400
Šířka zubu $B_1$	5.9	Průměr válečku	7.750

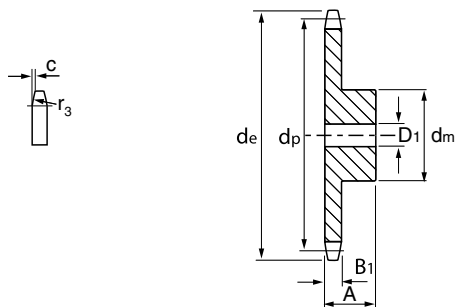

Typ 1 (C45)

Zuby	Vnější prům. $d_e$	Průměr rozteče $d_p$	Průměr náboje $d_m$	Simplex Délka přes vývrt A	Vývrt $D_1$	Typ
8	38.5	33.18	20	25	10	1
9	41.5	37.13	24	25	10	1
10	46.2	41.10	26	25	10	1
11	49.6	45.07	29	25	10	1
12	53.9	49.07	33	28	10	1
13	58.4	53.06	37	28	10	1
14	62.8	57.07	41	28	10	1
15	66.8	61.09	45	28	10	1
16	70.9	65.10	50	28	12	1
17	74.9	69.11	52	28	12	1
18	78.9	73.14	56	28	12	1
19	82.9	77.16	60	28	12	1
20	86.9	81.19	64	28	12	1
21	91.0	85.22	68	28	14	1
22	95.0	89.24	70	28	14	1
23	99.0	93.27	70	28	14	1
24	103.0	97.29	70	28	14	1
25	107.1	101.33	70	28	14	1
26	111.2	105.36	70	30	16	1
27	115.4	109.40	70	30	16	1
28	119.4	113.42	70	30	16	1
29	123.4	117.46	80	30	16	1
30	127.5	121.50	80	30	16	1
31	131.5	125.54	90	30	16	1
32	135.5	129.56	90	30	16	1
33	139.6	133.60	90	30	16	1
34	143.6	137.64	90	30	16	1
35	147.6	141.68	90	30	16	1
36	151.7	145.72	90	35	16	1
37	155.7	149.76	90	35	16	1
38	159.8	153.80	90	35	16	1
39	163.8	157.83	90	35	16	1
40	167.8	161.87	90	35	16	1

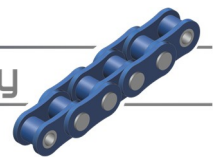

## BS Řetězová kola – s nábojem

**08B 1/2" x 5/16"**

ŘETĚZOVÉ KOLO	mm	ŘETĚZ	mm	
Poloměr zubu $r_3$	13.0	Rozteč	12.700	
Poloměr c	1.3	Šířka mezi vnitřními destičkami	7.750	
Šířka zubu $b_1$	7.0	Průměr válečku	8.510	
Šířka zubu $B_1$	7.2			
Šířka zubu $B_2$	21.0			
Šířka zubu $B_3$	34.9			

Zuby	Vnější prům. $d_e$	Průměr rozteče $d_p$	Průměr náboje $d_m$	Simplex		Duplex			Triplex			Typ
				Průměr náboje $d_m$	Délka přes vývrt A	Vývrt D1	Průměr náboje $d_m$	Délka přes vývrt A	Vývrt D1	Průměr náboje $d_m$	Délka přes vývrt A	
8	37.2	33.18	20	25	10	20	32	10	20	46	10	1
9	41.0	37.13	24	25	10	24	32	10	24	46	12	1
10	45.2	41.10	26	25	10	28	32	10	28	46	12	1
11	48.7	45.07	29	25	10	32	35	12	32	50	16	1
12	53.0	49.07	33	28	10	35	35	12	35	50	16	1
13	57.4	53.06	37	28	10	38	35	12	38	50	16	1
14	61.8	57.07	41	28	10	42	35	12	42	50	16	1
15	65.5	61.09	45	28	10	46	35	12	46	50	16	1
16	69.5	65.10	50	28	12	50	38	14	50	50	16	1
17	73.6	69.11	52	28	12	54	38	14	54	50	16	1
18	77.8	73.14	56	28	12	58	38	14	58	50	16	1
19	81.7	77.16	60	28	12	62	38	14	62	50	16	1
20	85.8	81.19	64	28	12	66	38	14	66	50	16	1
21	89.7	85.22	68	28	14	70	40	16	70	55	20	1
22	93.8	89.24	70	28	14	70	40	16	70	55	20	1
23	98.2	93.27	70	28	14	70	40	16	70	55	20	1
24	101.8	97.29	70	28	14	75	40	16	75	55	20	1
25	105.8	101.33	70	28	14	80	40	16	80	55	20	1
26	110.0	105.36	70	30	16	85	40	20	85	55	20	1
27	114.0	109.40	70	30	16	85	40	20	85	55	20	1
28	118.0	113.42	70	30	16	90	40	20	90	55	20	1
29	122.0	117.46	80	30	16	95	40	20	95	55	20	1
30	126.1	121.50	80	30	16	100	40	20	100	55	20	1
31	130.2	125.54	90	30	16	100	40	20	110	55	20	1
32	134.3	129.56	90	30	16	100	40	20	110	55	20	1
33	138.4	133.60	90	30	16	100	40	20	110	55	20	1
34	142.6	137.64	90	30	16	100	40	20	110	55	20	1
35	146.7	141.68	90	30	16	100	40	20	110	55	20	1
36	151.0	145.72	90	35	20	100	40	20	120	55	25	1
37	154.6	149.76	90	35	20	100	40	20	120	55	25	1
38	158.6	153.80	90	35	20	100	40	20	120	55	25	1
39	162.7	157.83	90	35	20	100	40	20	120	55	25	1
40	166.8	161.87	90	35	20	100	40	20	120	55	25	1
38	158.6	153.80	70	40	24	90	50	24	100	60	24	2
45	188.0	182.07	70	40	24	90	50	24	100	60	24	2
57	236.4	230.54	70	40	24	90	50	24	100	60	24	2
76	313.3	307.33	80	40	24	100	56	24	100	60	24	2
95	390.1	384.11	80	45	24	100	56	24	120	67	24	2
114	466.9	460.90	80	45	25	100	63	25	120	67	25	2

Všechny rozměry jsou v milimetrech, pokud není uvedeno jinak.

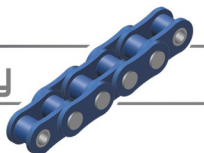

# Řetězová kola

## BS Řetězová kola – s nábojem

**10B 5/8" x 3/8"**

<b>ŘETĚZOVÉ KOLO</b>	mm	<b>CHAIN</b>	mm	
Poloměr zubu r <sub>3</sub>	16.0	Rozteč	15.875	
Poloměr c	1.6	Šířka mezi vnitřními destičkami	9.650	
Šířka zubu b <sub>1</sub>	9.0	Průměr válečku	10.160	
Šířka zubu B <sub>1</sub>	9.1			
Šířka zubu B <sub>2</sub>	25.5			
Šířka zubu B <sub>3</sub>	42.1			

Zuby	Vnější prům. de	Průměr rozteče dp	Průměr náboje dm	Simplex		Duplex			Triplex			Typ
				Délka přes vývrt A	Vývrt D1	Průměr náboje dm	Délka přes vývrt A	Vývrt D1	Průměr náboje dm	Délka přes vývrt A	Vývrt D1	
8	47.0	41.48	25	25	10	25	40	12	25	55	12	1
9	52.6	46.42	30	25	10	30	40	12	30	55	12	1
10	57.5	51.37	35	25	10	35	40	12	35	55	16	1
11	63.0	56.34	37	30	12	39	40	14	39	55	16	1
12	68.0	61.34	42	30	12	44	40	14	44	55	16	1
13	73.0	66.32	47	30	12	49	40	14	49	55	16	1
14	78.0	71.34	52	30	12	54	40	14	54	55	16	1
15	83.0	76.36	57	30	12	59	40	14	59	55	16	1
16	88.0	81.37	60	30	14	64	45	16	64	60	16	1
17	93.0	86.39	60	30	14	69	45	16	69	60	16	1
18	98.3	91.42	70	30	14	74	45	16	74	60	16	1
19	103.3	96.45	70	30	14	79	45	16	79	60	16	1
20	108.4	101.49	75	30	14	84	45	16	84	60	16	1
21	113.4	106.52	75	30	16	85	45	16	85	60	20	1
22	118.0	111.55	80	30	16	90	45	16	90	60	20	1
23	123.4	116.58	80	30	16	95	45	16	95	60	20	1
24	128.3	121.62	80	30	16	100	45	16	100	60	20	1
25	134.0	126.66	80	30	16	105	45	16	105	60	20	1
26	139.0	131.70	85	35	20	110	45	20	110	60	20	1
27	144.0	136.75	85	35	20	110	45	20	110	60	20	1
28	148.7	141.78	90	35	20	115	45	20	115	60	20	1
29	153.8	146.83	90	35	20	115	45	20	115	60	20	1
30	158.8	151.87	90	35	20	120	45	20	120	60	20	1
31	163.9	156.92	95	35	20	120	45	20	120	60	20	1
32	168.9	161.95	95	35	20	120	45	20	120	60	20	1
33	174.5	167.00	95	35	20	120	45	20	120	60	20	1
34	179.0	172.05	95	35	20	120	45	20	120	60	20	1
35	184.1	177.10	95	35	20	120	45	20	120	60	20	1
36	189.1	182.15	100	35	20	120	45	20	120	60	25	1
37	194.2	187.20	100	35	20	120	45	20	120	60	25	1
38	199.2	192.24	100	35	20	120	45	20	120	60	25	1
39	204.2	197.29	100	35	20	120	45	20	120	60	25	1
40	209.3	202.34	100	35	20	120	45	20	120	60	25	1
38	199.2	192.24	80	40	24	100	50	30	100	60	32	2
45	235.0	227.58	80	40	24	100	50	30	100	60	32	2
57	296.0	288.18	90	45	24	100	56	30	100	63	32	2
76	392.1	384.16	90	50	24	100	63	30	110	67	35	2
95	488.5	480.14	100	56	24	110	63	30	125	70	35	2
114	584.1	576.13	100	56	25	125	70	30	125	80	35	2

Všechny rozměry jsou v milimetrech, pokud není uvedeno jinak.



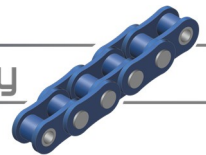

## BS Řetězová kola – s nábojem

**12B 3/4" x 7/16"**

ŘETĚZOVÉ KOLO	mm	ŘETĚZ	mm			
Poloměr zubu $r_3$	19.0	Rozteč	19.050			
Poloměr c	2.0	Šířka mezi vnitřními destičkami	11.680			
Šířka zubu $b_1$	10.8	Průměr válečku	12.070			
Šířka zubu $B_1$	11.1					
Šířka zubu $B_2$	30.3					
Šířka zubu $B_3$	49.8					

Zuby	Vnější prům. $d_e$	Průměr rozteče $d_p$	Průměr náboje $d_m$	Simplex			Duplex			Triplex			Typ
				Průměr náboje $d_m$	Délka přes vývrt A	Vývrt D1	Průměr náboje $d_m$	Délka přes vývrt A	Vývrt D1	Průměr náboje $d_m$	Délka přes vývrt A	Vývrt D1	
8	57.6	49.78	31	30	12	31	45	12	31	65	16	1	
9	62.0	55.70	37	30	12	37	45	12	37	65	16	1	
10	69.0	61.64	42	30	12	42	45	12	42	65	16	1	
11	75.0	67.61	46	35	14	47	50	16	47	70	20	1	
12	81.5	73.60	52	35	14	53	50	16	53	70	20	1	
13	87.5	79.59	58	35	14	59	50	16	59	70	20	1	
14	93.6	85.61	64	35	14	65	50	16	65	70	20	1	
15	99.8	91.63	70	35	14	71	50	16	71	70	20	1	
16	105.5	97.65	75	35	16	77	50	20	77	70	20	1	
17	111.5	103.67	80	35	16	83	50	20	83	70	20	1	
18	118.0	109.71	80	35	16	89	50	20	89	70	20	1	
19	124.2	115.75	80	35	16	95	50	20	95	70	20	1	
20	129.7	121.78	80	35	16	100	50	20	100	70	20	1	
21	136.0	127.82	90	40	20	100	50	20	100	70	20	1	
22	141.8	133.86	90	40	20	100	50	20	100	70	20	1	
23	149.0	139.90	90	40	20	110	50	20	110	70	20	1	
24	153.9	145.94	90	40	20	110	50	20	110	70	20	1	
25	160.0	152.00	90	40	20	120	50	20	120	70	20	1	
26	165.9	158.04	95	40	20	120	50	20	120	70	20	1	
27	172.3	164.09	95	40	20	120	50	20	120	70	20	1	
28	178.0	170.13	95	40	20	120	50	20	120	70	20	1	
29	184.1	176.19	95	40	20	120	50	20	120	70	20	1	
30	190.5	182.25	95	40	20	120	50	20	120	70	20	1	
31	196.3	188.31	100	40	20	120	50	20	130	70	25	1	
32	203.3	194.35	100	40	20	120	50	20	130	70	25	1	
33	209.3	200.40	100	40	20	120	50	20	130	70	25	1	
34	214.6	206.46	100	40	20	120	50	20	130	70	25	1	
35	221.0	212.52	100	40	20	120	50	20	130	70	25	1	
36	226.8	218.58	100	40	25	120	50	25	130	70	25	1	
37	232.9	224.64	100	40	25	120	50	25	130	70	25	1	
38	239.0	230.69	100	40	25	120	50	25	130	70	25	1	
39	245.1	236.75	100	40	25	120	50	25	130	70	25	1	
40	251.3	242.81	100	40	25	120	50	25	130	70	25	1	
38	239.0	230.69	100	56	24	110	63	30	140	70	30	2	
45	282.5	273.10	100	56	24	110	63	30	140	70	30	2	
57	355.4	345.81	100	56	30	120	63	30	140	70	40	2	
76	469.9	460.99	100	56	30	135	63	30	160	75	40	2	
95	585.1	576.17	100	65	30	135	70	30	170	82	40	2	
114	700.6	691.36	100	65	30	135	70	30	170	82	40	2	

Všechny rozměry jsou v milimetrech, pokud není uvedeno jinak.

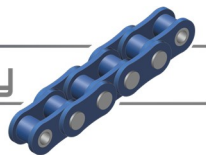

# Řetězová kola

## BS Řetězová kola – s nábojem

16B 1" x 17.02 mm

ŘETĚZOVÉ KOLO	mm	CHAIN	mm	
Poloměr zubu $r_3$	26.0	Rozteč	25.400	
Poloměr c	2.5	Šířka mezi vnitřními destičkami	17.020	
Šířka zubu $b_1$	15.8	Průměr válečku	15.880	
Šířka zubu $B_1$	16.2			
Šířka zubu $B_2$	47.7			
Šířka zubu $B_3$	79.6			

Zuby	Vnější prům. $d_e$	Průměr rozteče $d_p$	Simplex			Duplex			Triplex			Typ
			Průměr náboje $d_m$	Délka přes vývrt A	Vývrt D1	Průměr náboje $d_m$	Délka přes vývrt A	Vývrt D1	Průměr náboje $d_m$	Délka přes vývrt A	Vývrt D1	
8	77.0	66.37	42	35	16	42	65	16	42	95	20	1
9	85.0	74.27	50	35	16	50	65	16	50	95	20	1
10	93.0	82.19	55	35	16	56	65	16	56	95	20	1
11	99.5	90.14	61	40	16	64	70	20	64	100	25	1
12	109.0	98.14	69	40	16	72	70	20	72	100	25	1
13	117.0	106.12	78	40	16	80	70	20	80	100	25	1
14	125.0	114.15	84	40	16	88	70	20	88	100	25	1
15	133.0	122.17	92	40	16	96	70	20	96	100	25	1
16	141.0	130.20	100	45	20	104	70	25	104	100	30	1
17	149.0	138.22	100	45	20	112	70	25	112	100	30	1
18	157.0	146.28	100	45	20	120	70	25	120	100	30	1
19	165.2	154.33	100	45	20	128	70	25	128	100	30	1
20	173.2	162.38	100	45	20	130	70	25	130	100	30	1
21	181.2	170.43	110	50	20	130	70	25	130	100	30	1
22	189.3	178.48	110	50	20	130	70	25	130	100	30	1
23	197.5	186.53	110	50	20	130	70	25	130	100	30	1
24	205.5	194.59	110	50	20	130	70	25	130	100	30	1
25	213.5	202.66	110	50	20	130	70	25	130	100	30	1
26	221.6	210.72	120	50	20	130	70	25	130	100	30	1
27	229.6	218.79	120	50	20	130	70	25	130	100	30	1
28	237.7	226.85	120	50	20	130	70	25	130	100	30	1
29	245.8	234.92	120	50	20	130	70	25	130	100	30	1
30	254.0	243.00	120	50	20	130	70	25	130	100	30	1
31	262.0	251.08	120	50	25	140	70	25	140	100	30	1
32	270.0	259.13	120	50	25	140	70	25	140	100	30	1
33	278.5	267.21	120	50	25	140	70	25	140	100	30	1
34	287.0	275.28	120	50	25	140	70	25	140	100	30	1
35	296.2	283.36	120	50	25	140	70	25	140	100	30	1
36	304.6	291.44	120	50	25	140	70	25	140	100	30	1
37	312.6	299.51	120	50	25	140	70	25	140	100	30	1
38	320.7	307.59	120	50	25	140	70	25	140	100	30	1
39	328.8	315.67	120	50	25	140	70	25	140	100	30	1
40	336.9	323.75	120	50	25	140	70	25	140	100	30	1
30	254.0	243.00	110	65	30	125	75	40	145	90	40	2
38	320.0	307.59	110	65	30	140	75	40	160	100	45	2
45	377.0	364.12	125	70	30	150	75	40	160	100	45	2
57	474.0	461.07	125	70	35	170	90	40	165	100	45	2
76	627.0	614.65	140	80	35	175	95	40	200	110	45	2
95	781.0	768.22	140	80	40	175	95	45	200	110	50	2

Všechny rozměry jsou v milimetrech, pokud není uvedeno jinak.

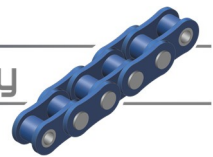

## BS Řetězová kola – s nábojem

20B

1.1/4" x 3/4"

**ŘETĚZOVÉ KOLO**

Poloměr zubu $r_3$	32.0
Poloměr $c$	3.5
Šířka zubu $b_1$	18.2
Šířka zubu $B_1$	18.5
Šířka zubu $B_2$	54.6
Šířka zubu $B_3$	91.0

**ŘETĚZ**

Rozteč	31.750
Šířka mezi vnitřními destičkami	19.560
Průměr válečku	19.050

mm

31.750

19.560

19.050

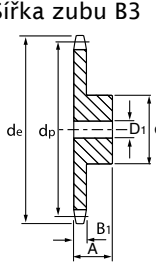

Typ 1 (C45)

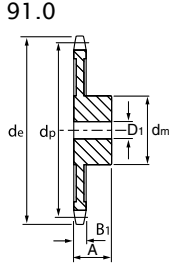

Typ 2 (GG22)

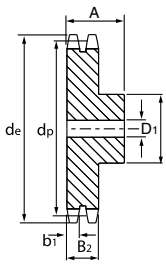

Typ 1 (C45)

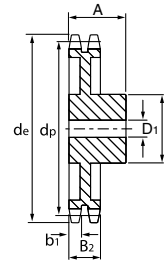

Typ 2 (GG22)

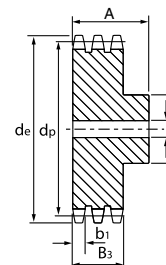

Typ 1 (C45)

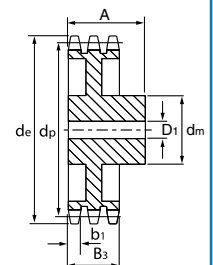

Typ 2 (GG22)

Zuby	Vnější prům. $d_e$	Průměr rozteče $d_p$	Průměr náboje $d_m$	Simplex		Duplex			Triplex			Typ
				Průměr náboje $d_m$	Délka přes vývrt A	Vývrt D1	Průměr náboje $d_m$	Délka přes vývrt A	Vývrt D1	Průměr náboje $d_m$	Délka přes vývrt A	
8	98.1	82.96	53	40	20	53	75	20	53	110	25	1
9	108.0	92.84	63	40	20	63	75	20	63	110	25	1
10	117.9	102.74	70	40	20	70	75	20	70	110	25	1
11	127.8	112.68	77	45	20	80	80	25	80	115	30	1
12	137.8	122.68	88	45	20	90	80	25	90	115	30	1
13	147.8	132.65	98	45	20	100	80	25	100	115	30	1
14	157.8	142.68	108	45	20	110	80	25	110	115	30	1
15	167.9	152.72	118	45	20	120	80	25	120	115	30	1
16	177.9	162.75	120	50	25	120	80	30	120	115	30	1
17	187.9	172.78	120	50	25	120	80	30	120	115	30	1
18	198.0	182.85	120	50	25	120	80	30	120	115	30	1
19	208.1	192.91	120	50	25	120	80	30	120	115	30	1
20	218.1	202.98	120	50	25	120	80	30	120	115	30	1
21	228.2	213.04	140	55	30	140	80	30	140	115	30	1
22	238.3	223.11	140	55	30	140	80	30	140	115	30	1
23	248.3	233.17	140	55	30	140	80	30	140	115	30	1
24	258.4	243.23	140	55	30	140	80	30	140	115	30	1
25	268.5	253.33	140	55	30	140	80	30	140	115	30	1
26	278.6	263.40	150	55	30	150	80	30	150	115	30	1
27	288.6	273.80	150	55	30	150	80	30	150	115	30	1
28	298.7	283.56	150	55	30	150	80	30	150	115	30	1
29	308.8	293.65	150	55	30	150	80	30	150	115	30	1
30	318.9	303.75	150	55	30	150	80	30	150	115	30	1
31	329.0	313.85	150	55	30	150	80	30	150	115	30	1
32	339.1	323.91	150	55	30	150	80	30	150	115	30	1
33	349.2	334.01	150	55	30	150	80	30	150	115	30	1
34	359.3	344.10	150	55	30	150	80	30	150	115	30	1
35	369.4	354.20	150	55	30	150	80	30	150	115	30	1
36	379.5	364.30	150	55	30	150	80	30	150	115	30	1
37	389.5	374.39	150	55	30	150	80	30	150	115	30	1
38	399.6	384.49	150	55	30	150	80	30	150	115	30	1
39	409.7	394.59	150	55	30	150	80	30	150	115	30	1
40	419.8	404.66	150	55	30	150	80	30	150	115	30	1
30	318.9	303.75	115	70	35	130	80	40	160	100	50	2
38	399.6	384.49	125	70	35	140	90	45	180	110	56	2
45	470.3	455.17	125	70	35	140	90	45	180	110	56	2
57	591.5	576.36	135	80	40	160	100	50	180	125	63	2
76	783.5	768.32	140	90	50	180	100	56	200	140	63	2
95	976.9	960.28	-	-	-	180	100	60	220	140	70	2

Všechny rozměry jsou v milimetrech, pokud není uvedeno jinak.

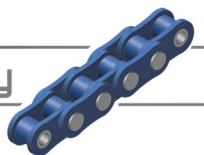

### BS Řetězová kola – s nábojem

**24B 1.1/2" x 1"**

ŘETĚZOVÉ KOLO mm  
 Poloměr zubu  $r_3$  38.0  
 Poloměr  $c$  4.0  
 Šířka zubu  $b_1$  23.6  
 Šířka zubu  $B_1$  24.1  
 Šířka zubu  $B_2$  72.0  
 Šířka zubu  $B_3$  120.3

ŘETĚZ mm  
 Rozteč 38.100  
 Šířka mezi vnitřními destičkami 25.400  
 Průměr válečku 25.400

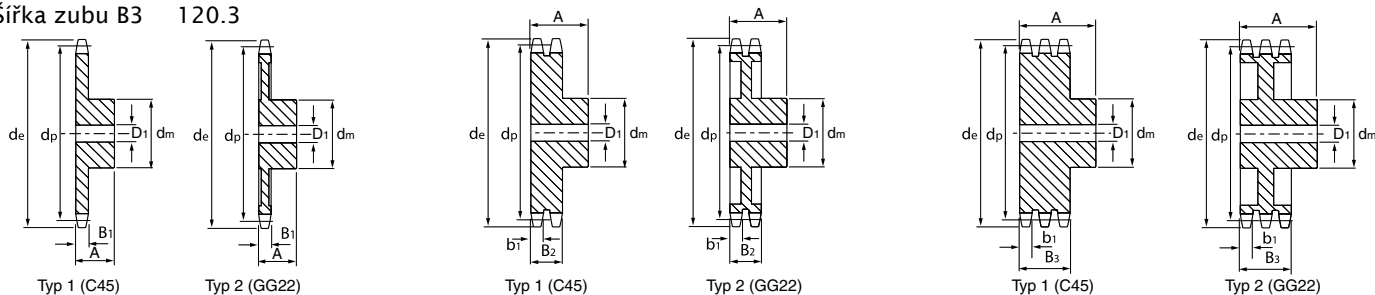
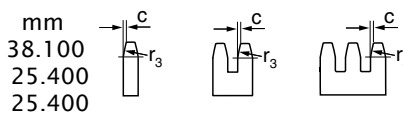

Zuby	Vnější prům. $d_e$	Průměr rozteče $d_p$	Průměr náboje $d_m$	Simplex		Duplex			Triplex			Typ
				Průměr náboje $d_m$	Délka přes vývrt $A$	Vývrt $D1$	Průměr náboje $d_m$	Délka přes vývrt $A$	Vývrt $D1$	Průměr náboje $d_m$	Délka přes vývrt $A$	
8	115.0	99.55	58	45	20	58	95	25	58	140	25	1
9	126.4	111.40	70	45	20	70	95	25	70	140	25	1
10	138.0	123.29	80	45	20	80	95	25	80	140	25	1
11	150.0	135.21	90	50	25	90	100	25	90	150	30	1
12	162.0	147.22	102	50	25	102	100	25	102	150	30	1
13	174.2	159.18	114	50	25	114	100	25	114	150	30	1
14	186.2	171.22	128	50	25	128	100	25	128	150	30	1
15	198.2	183.26	140	50	25	140	100	25	132	150	30	1
16	210.3	195.30	140	55	25	140	100	30	136	150	30	1
17	222.3	207.34	140	55	25	150	100	30	140	150	30	1
18	234.3	219.42	140	55	25	150	100	30	150	150	30	1
19	246.5	231.49	140	55	25	160	100	30	160	150	30	1
20	258.6	243.57	140	55	25	160	100	30	160	150	30	1
21	270.6	255.65	150	60	30	160	100	30	160	150	40	1
22	282.7	267.73	150	60	30	160	100	30	160	150	40	1
23	294.8	279.80	150	60	30	160	100	30	160	150	40	1
24	306.8	291.88	150	60	30	160	100	30	160	150	40	1
25	319.0	304.00	150	60	30	160	100	30	160	150	40	1
26	331.0	316.08	160	60	30	160	100	30	160	150	40	1
27	343.2	328.19	160	60	30	160	100	30	160	150	40	1
28	355.2	340.27	160	60	30	160	100	30	160	150	40	1
29	367.3	352.38	160	60	30	160	100	30	160	150	40	1
30	379.5	364.50	160	60	30	160	100	30	160	150	40	1
31	391.6	376.62	160	60	30	160	100	40	160	150	40	1
32	403.7	388.69	160	60	30	160	100	40	160	150	40	1
33	415.8	400.81	160	60	30	160	100	40	160	150	40	1
34	427.8	412.93	160	60	30	160	100	40	160	150	40	1
35	440.0	425.04	160	60	30	160	100	40	160	150	40	1
36	452.0	437.16	160	60	30	160	100	40	160	150	40	1
37	464.2	449.27	160	60	30	160	100	40	160	150	40	1
38	476.2	461.39	160	60	30	160	100	40	160	150	40	1
39	488.5	473.50	160	60	30	160	100	40	160	150	40	1
40	500.6	485.62	160	60	30	160	100	40	160	150	40	1
30	379.5	364.50	130	85	40	160	95	40	180	150	60	2
38	476.2	461.39	140	90	45	180	100	45	200	150	60	2
45	561.2	546.20	140	90	45	180	100	45	200	150	60	2
57	706.5	691.63	160	100	45	200	110	55	200	150	70	2
76	936.9	921.98	170	100	45	220	120	55	-	-	-	2
95	1167.3	1152.33	200	125	50	220	140	55	-	-	-	2
114	1402.8	1382.72	-	-	-	-	-	-	230	160	75	2

Všechny rozměry jsou v milimetrech, pokud není uvedeno jinak.

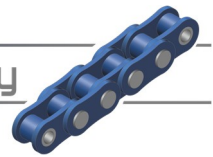

## BS Řetězová kola – s nábojem

**28B 1.3/4" x 1.1/4"**

ŘETĚZOVÉ KOLO mm  
 Poloměr zubu  $r_3$  44.0  
 Poloměr  $c$  5.0  
 Šířka zubu  $b_1$  28.8  
 Šířka zubu  $B_1$  29.4  
 Šířka zubu  $B_2$  88.4  
 Šířka zubu  $B_3$  148.0

ŘETĚZ  
 Rozteč  
 Šířka mezi vnitřními destičkami  
 Průměr válečku

mm  
 44.450  
 30.990  
 27.940

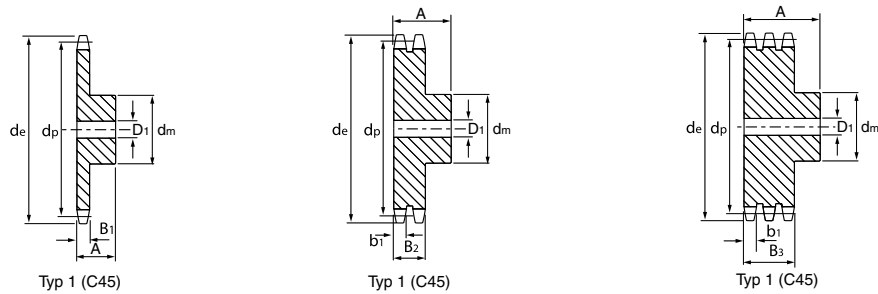

Zuby	Vnější prům. $d_e$	Průměr rozteče $d_p$	Průměr náboje $d_m$	Simplex		Duplex			Triplex			Typ
				Průměr náboje $d_m$	Délka přes vývrt A	Vývrt D1	Průměr náboje $d_m$	Délka přes vývrt A	Vývrt D1	Průměr náboje $d_m$	Délka přes vývrt A	
8	132.0	116.15	74	70	25	74	120	30	74	180	30	1
9	148.4	129.96	88	70	25	88	120	30	88	180	30	1
10	162.3	143.85	100	70	25	100	120	30	100	180	30	1
11	176.3	157.77	112	70	25	112	120	30	112	180	30	1
12	189.3	171.74	125	70	25	125	120	30	125	180	30	1
13	204.2	185.75	125	70	25	125	120	30	125	180	30	1
14	218.2	199.76	130	70	25	130	120	30	130	180	30	1
15	232.3	213.79	145	70	25	145	120	30	145	180	30	1
16	246.3	227.84	160	75	30	160	120	30	160	180	30	1
17	260.0	241.90	160	75	30	160	120	30	160	180	30	1
18	274.0	255.98	160	75	30	160	120	30	160	180	30	1
19	289.0	270.06	160	75	30	180	120	30	180	180	30	1
20	303.0	284.15	160	75	30	180	120	30	180	180	30	1
21	317.0	298.24	170	75	30	180	120	30	180	180	40	1
22	331.0	312.34	170	75	30	180	120	30	180	180	40	1
23	345.0	326.44	170	75	30	180	120	30	180	180	40	1
24	359.0	340.55	170	75	30	180	120	30	180	180	40	1
25	373.0	354.66	170	75	30	180	120	30	180	180	40	1
26	387.0	368.77	170	75	30	180	120	40	180	180	40	1
27	401.0	382.88	170	75	30	180	120	40	180	180	40	1
28	416.0	397.00	170	75	30	180	120	40	180	180	40	1
29	430.0	411.12	170	75	30	180	120	40	180	180	40	1
30	444.0	425.24	170	75	30	180	120	40	180	180	40	1
31	458.0	439.37	180	75	30	200	120	40	200	180	40	1
32	472.0	453.49	180	75	30	200	120	40	200	180	40	1
33	486.0	467.62	180	75	30	200	120	40	200	180	40	1
34	500.0	481.75	180	75	30	200	120	40	200	180	40	1
35	514.0	495.88	180	75	30	200	120	40	200	180	40	1
36	529.0	510.01	180	75	30	200	120	40	200	180	40	1
37	543.0	524.13	180	75	30	200	120	40	200	180	40	1
38	557.0	538.27	180	75	30	200	120	40	200	180	40	1
39	571.0	552.40	180	75	30	200	120	40	200	180	40	1
40	585.0	566.54	180	75	30	200	120	40	200	180	40	1

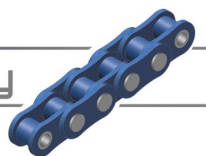

# Řetězová kola

## BS Řetězová kola – s nábojem

**32B 2" x 1.1/4"**

ŘETĚZOVÉ KOLO	mm
Poloměr zubu $r_3$	51.0
Poloměr $c$	6.0
Šířka zubu $b_1$	28.8
Šířka zubu $B_1$	29.4
Šířka zubu $B_2$	87.4
Šířka zubu $B_3$	146.0

ŘETĚZ	mm
Rozteč	50.800
Šířka mezi vnitřními destičkami	30.990
Průměr válečku	29.210

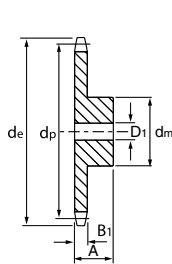
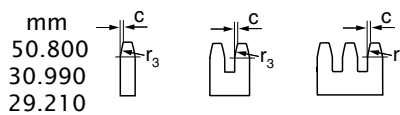

Typ 1 (C45)

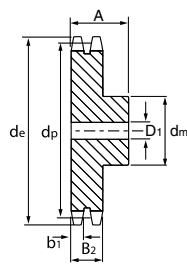

Typ 1 (C45)

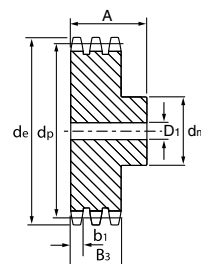

Typ 1 (C45)

Zuby	Vnější prům. $d_e$	Průměr rozteče $d_p$	Průměr náboje $d_m$	Simplex		Duplex			Triplex			Typ
				Délka přes vývrt A	Vývrt D1	Průměr náboje $d_m$	Délka přes vývrt A	Vývrt D1	Průměr náboje $d_m$	Délka přes vývrt A	Vývrt D1	
8	153.2	132.74	85	80	30	85	120	30	85	180	30	1
9	169.0	148.54	100	80	30	100	120	30	100	180	30	1
10	185.0	164.39	115	80	30	115	120	30	115	180	30	1
11	200.8	180.31	125	80	30	125	120	35	125	180	35	1
12	216.8	196.29	133	80	30	133	120	35	133	180	35	1
13	232.8	212.29	145	80	30	145	120	35	145	180	35	1
14	248.8	228.29	155	80	30	155	120	35	155	180	35	1
15	264.8	244.30	160	80	30	160	120	35	160	180	35	1
16	280.9	260.40	160	90	30	160	120	40	160	180	40	1
17	296.9	276.46	170	90	30	180	120	40	180	180	40	1
18	313.0	292.55	170	90	30	180	120	40	180	180	40	1
19	329.1	308.66	170	90	30	200	120	40	200	180	40	1
20	345.2	324.71	180	90	30	200	120	40	200	180	40	1
21	361.3	340.82	180	90	40	200	120	40	200	180	40	1
22	377.5	356.98	180	90	40	200	120	40	200	180	40	1
23	393.6	373.08	180	90	40	200	120	40	200	180	40	1
24	409.7	389.18	180	90	40	200	120	40	200	180	40	1
25	425.8	405.33	180	90	40	200	120	40	200	180	40	1
26	441.9	421.44	180	90	40	200	120	40	200	180	40	1
27	458.1	437.59	180	90	40	200	120	40	200	180	40	1
28	474.2	453.69	180	90	40	200	120	40	200	180	40	1
29	492.0	469.85	180	90	40	-	-	-	-	-	-	1
30	506.5	486.00	180	90	40	200	120	40	200	180	40	1
32	538.8	518.27	180	90	40	-	-	-	-	-	-	1
35	589.5	566.71	180	90	40	-	-	-	-	-	-	1
38	635.5	615.16	180	90	40	-	-	-	-	-	-	1
40	670.3	647.47	180	90	40	-	-	-	-	-	-	1